

Product Bulletin for
Occupancy & Vacancy Sensor



Sensor

Occupancy & Vacancy

Light up your home in a gentle night

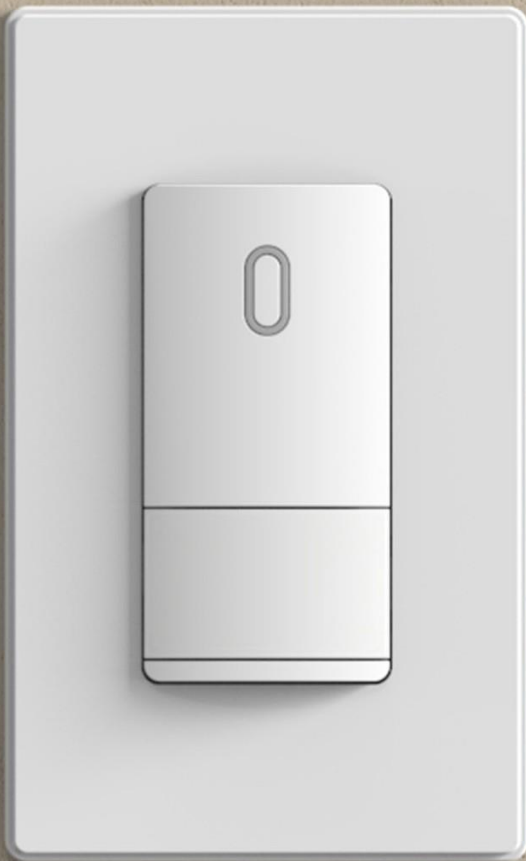

Top View

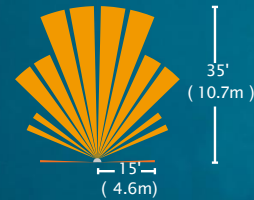

Side View

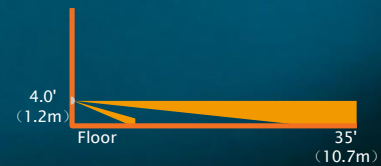

Features and Benefits

- Low Noise and High Sensitivity.
- Automatic ON or Manual ON is optional.
- Automatic Off.
- 180° coverage of up to 900 sq. ft.
- Adjustable sensitivity from 20% to 100%.
- Adjustable time delay from 15 seconds to 30 minutes.
- Pet immunity (reduce false triggers).
- Detect ambient light to adjust light's brightness.



Manual Light Switch

The whole cover could be used as a manual light switch and is removable to access setting controls

Adjustable Light Level

Detect ambient light to adjust lamp brightness



Adjustable Sensitivity

from 20% to 100%

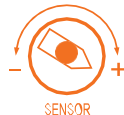

Adjustable Delay Time

from 30 seconds to 30 minutes



PIR Motion Detector

Only detect human body movement, reduce false triggers from pets



Incandescent Lamp

600W, 120-277V



CFL Lamp

300W, 120-277V



Dimmable LED Lamp

300W, 120-277V



Dimensional

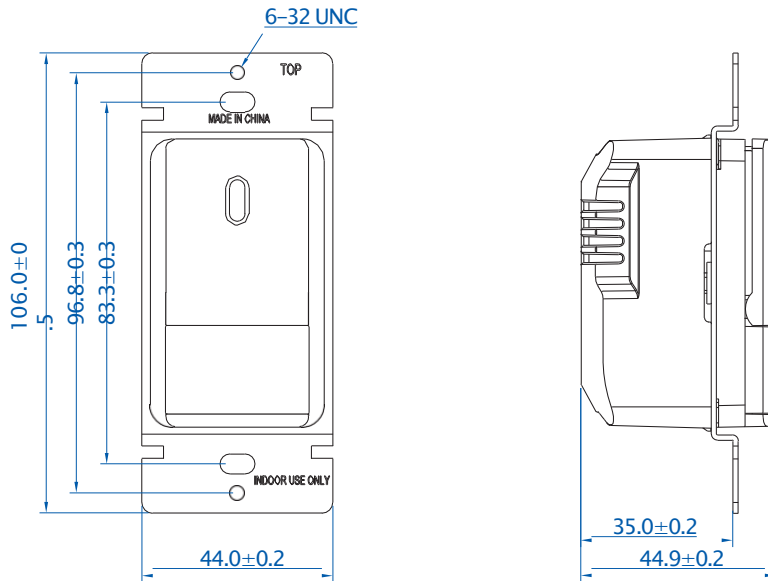

Height	106 ± 0.5 mm
Width	44.0 ± 0.2 mm
Depth	44.9 ± 0.2 mm

Photo	P/N	Rating	Description	Load Capacity	Option
	S3DOWH	120~277VAC 60HZ	Pyroelectric Infrared Sensor 1/2 HP Work with Copper Wire Only	Incandescent 600W LED/CFL 300W	Single Pole

PIR Wall Switch Vacancy Sensor

Photo	P/N	Rating	Description	Load Capacity	Option
	S3DVWH	120~277VAC 60HZ	Pyroelectric Infrared Sensor 1/2 HP Work with Copper Wire Only	Incandescent 600W LED/CFL 300W	Single Pole

Part Number Key

Device	Number of Poles	Style	Type	Color
S = Switch	1 = Single Pole 3 = Three Way 13 = Single Pole, Three Way	D = Decorative	O = Occupancy V = Vacancy	WH = White

